

SECTION A-A

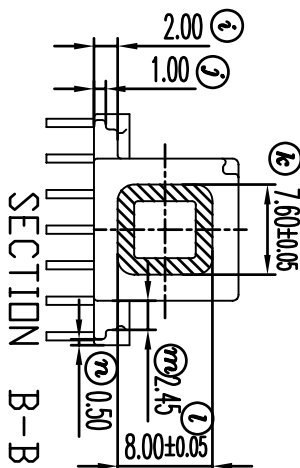

SECTION B-B

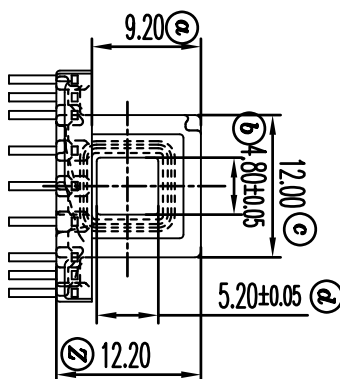
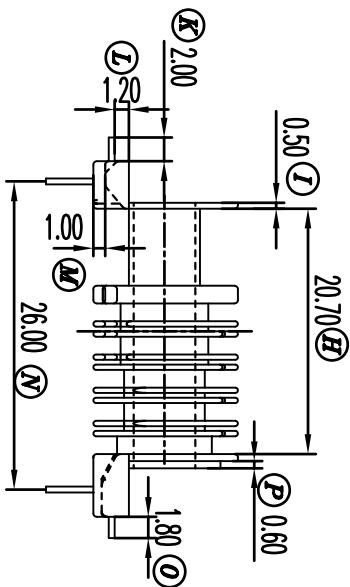
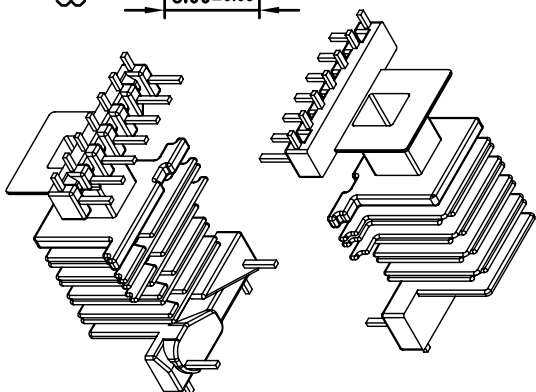

SECTION C-C

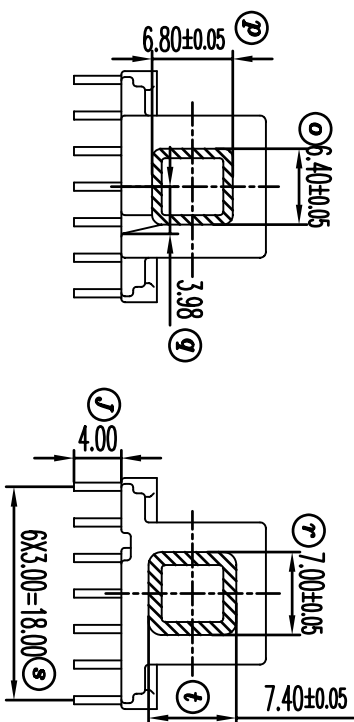

SECTION D-D

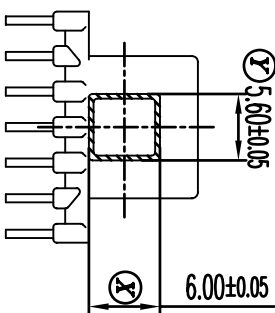
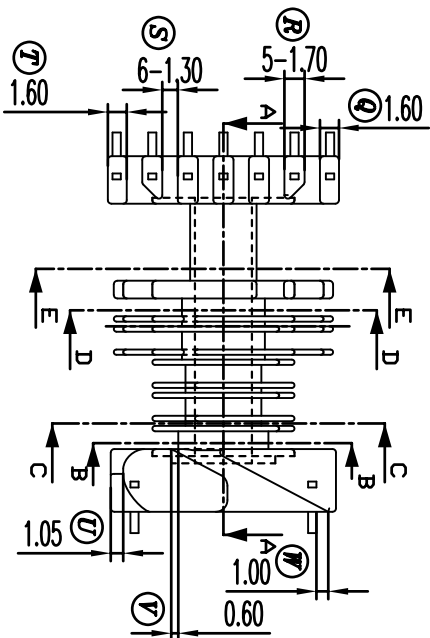

SECTION E-E

REV.	REVISION RECORD	DATE	REV.	REVISION RECORD	DATE
A			C		
B			D		

NAME	EEL-19-SW(DL形PIN) (9P)	MATERIAL	LCPI(E4008)	SCALE	2/1	ANGLE	±1°
DRAWING NO.	HY S1908	PIN MATERIAL	PHOSPHOR BRONZE	UNIT	m/m	REV.:	A
UL REC.34V-0	PIN TENION LOAD: 0.8kg	MIN					
TOLERANCES	0<L<10±0.1	10<L<20±0.15	20<L<40±0.2				
	PIN PITCH:±0.2	WALL THICKNESS:±0.05					

	信詠塑膠工業股份有限公司 HSIN YING PLASTIC INDUSTRIAL CO., LTD. TEL:886-2-29953711 FAX:86-2-29990010 TEL:07-69-6632011 FAX:07-69-6633843
--	---