

A0281

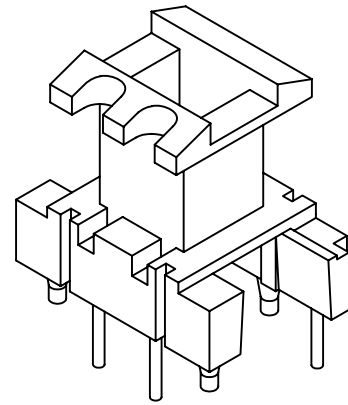

A0281-1

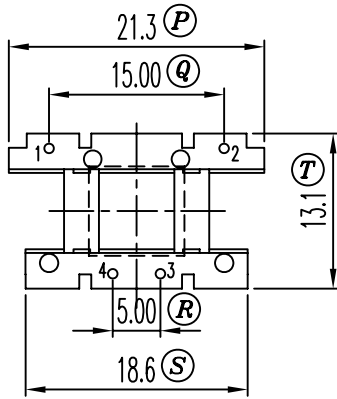
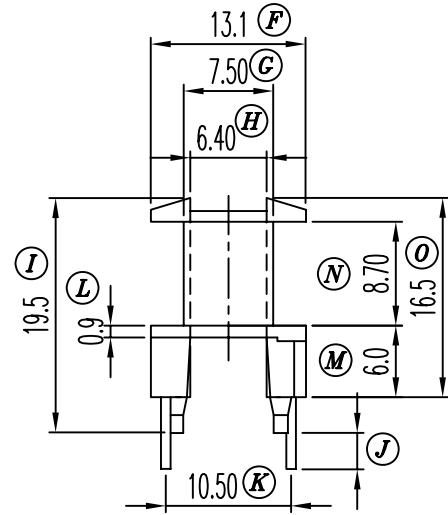
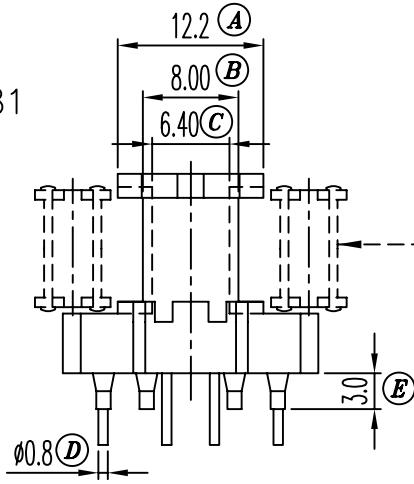
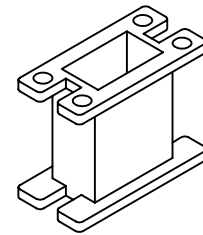
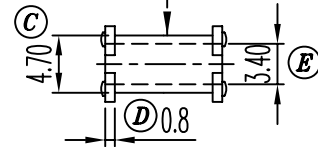
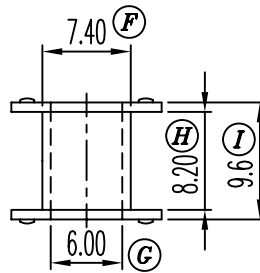
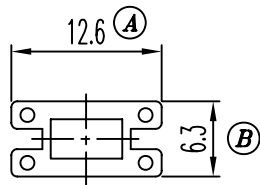

REV.	REVISION RECORD	DATE	REV.	REVISION RECORD	DATE
A			C		
B			D		

NAME	A0281 (4P)	MATERIAL	PBT	SCALE	1.5/1	ANGLE:	±1°
DRAWING NO.	HY 2204	PIN MATERIAL	CP WIRE	UNIT	m/m	REV.:	A
TOLERANCE OF PIN PITCH	±0.20		信詠塑膠工業股份有限公司 HSIN YUNG PLASTIC INDUSTRIAL CO., LTD. TEL: 886-2-29953711 FAX: 886-2-29990010 信詠塑膠電子廠 HSIN YUNG PLASTIC ELECTRONICS FACTORY TEL: 0769-6632011 FAX: 0769-6635843				
PIN TENSION LOAD	1.0kg MIN	UL REC.: 94V-0					
TOLERANCES: 0<L≤4:±0.1 4<L≤16:±0.2 16<L≤63:±0.3							