

SEC A-A

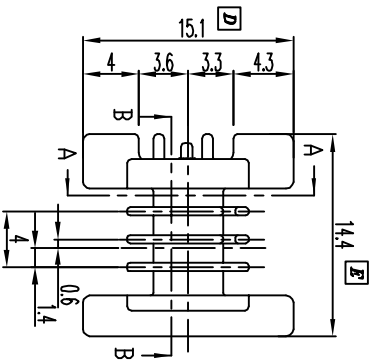

SEC B-B

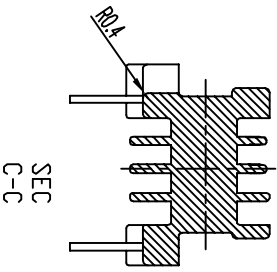
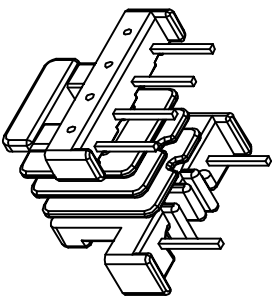
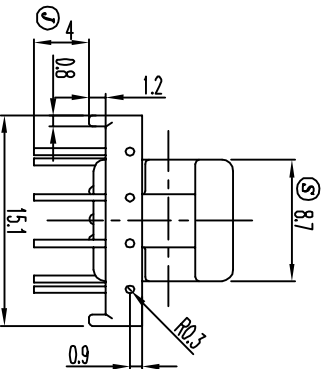
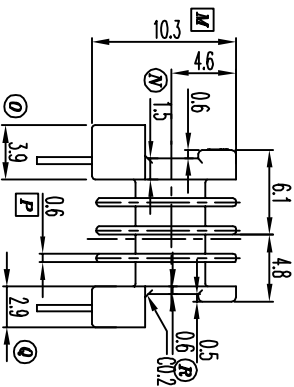
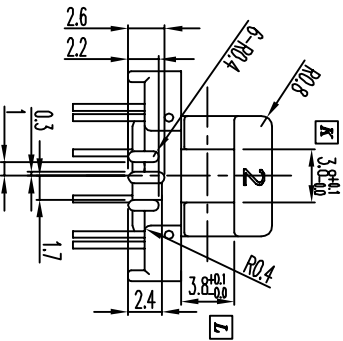
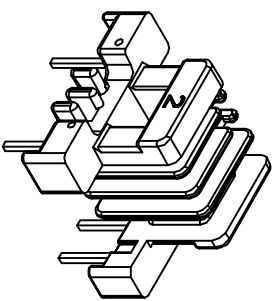

SEC C-C

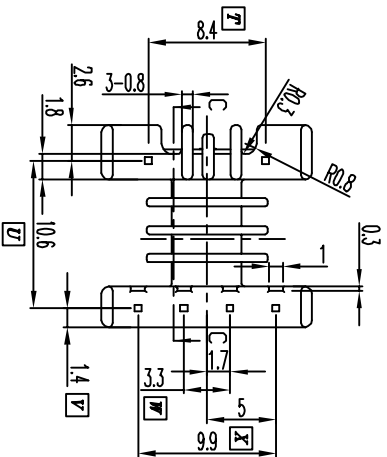

檢驗條件:

此產品是符合ROHS要求的.

A 代表重要尺寸
B 代表次要尺寸

① ②

REV.	REVISION RECORD	DATE	REV.	REVISION RECORD	DATE
A			C		
B			D		

NAME	SDR-MD-105-QM(BE-1413)	MATERIAL	PEBT-30A(C90R30)	SCALE	2/1	ANGLE:	±T
DRAWING NO.	HT1955	PIN MATERIAL		CP	WIRE	UNIT	m/m
UL REC.:94V-0	PIN TENSION LOAD:1.0KG MIN						REV.: A
TOLERANCES	0-3 ±0.04, 3-6 ±0.08, 6-10 ±0.08						
	10-18 ±0.07, 18-30 ±0.09, 30-50 ±0.10						
	PN PITCH±0.2 WALL THICKNESS±0.05						



信義塑膠工業股份有限公司
HSIN YUNG PLASTIC INDUSTRIAL CO., LTD.
信義塑膠電子廠
HSIN YUNG PLASTIC ELECTRONICS FACTORY