

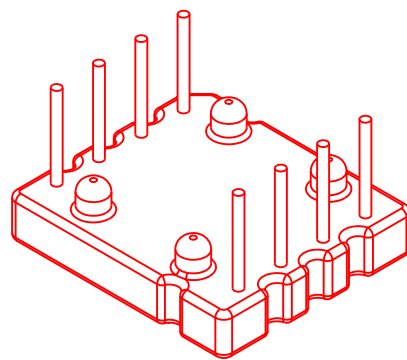

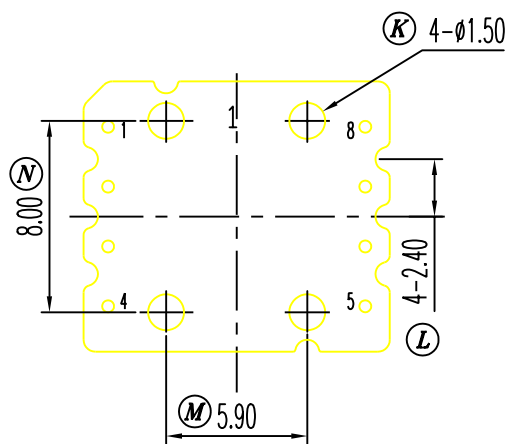

E-192738

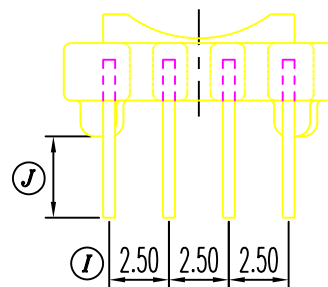
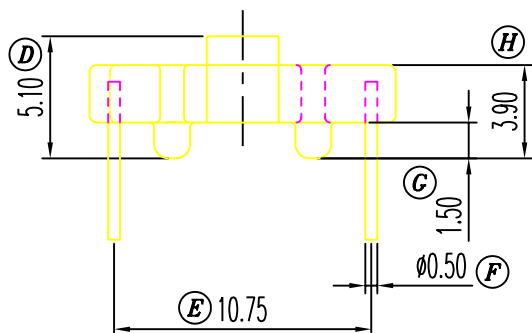
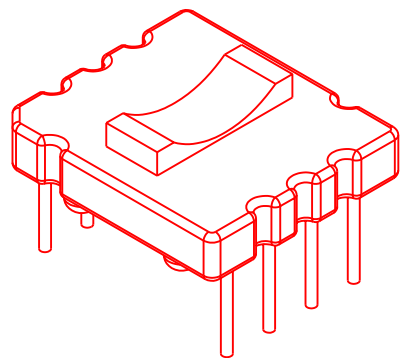
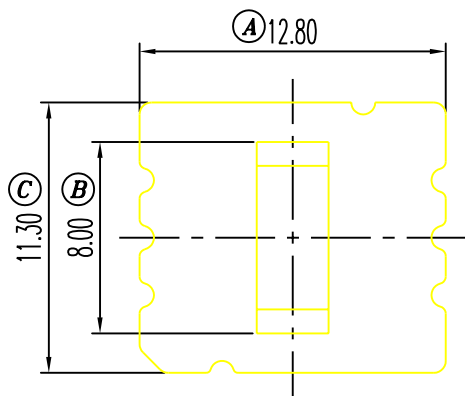

REV.	REVISION RECORD	DATE	REV.	REVISION RECORD	DATE
A			C		
B			D		

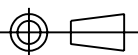
NAME	8P BASE-4	MATERIAL	PHENOLIC	SCALE	3/1	ANGLE:	±1°
DRAWING NO.	HYB085	PIN MATERIAL	CP WIRE	UNIT	m/m	REV.:	A
UL REC.:94V-0	PIN TENSION LOAD: 0.8kg MIN		 信詠塑膠工業股份有限公司 HSIN YUNG PLASTIC INDUSTRIAL CO.,LTD. TEL:886-2-29953711 FAX:886-2-29990010 信詠塑膠電子廠 HSIN YUNG PLASTIC ELECTRONICS FACTORY TEL:0769-86632011 FAX:0769-86635843				
TOLERANCES:	0<L≤4:±0.1 4<L≤16:±0.2 16<L≤63:±0.3						
	PIN PITCH:±0.2 WALL THICKNESS:±0.15						