

模號

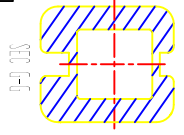

SEC G-G

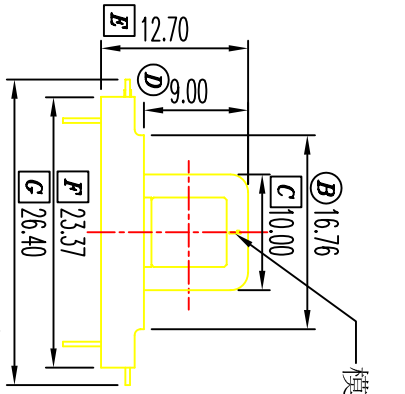
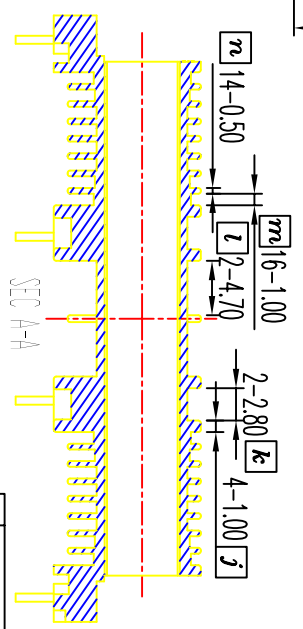
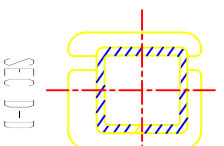
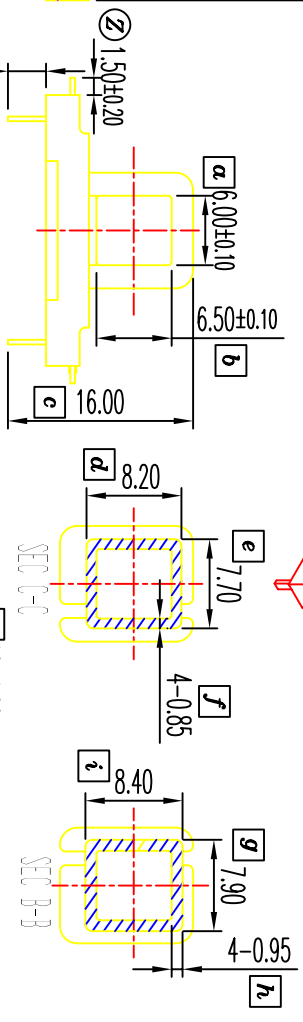
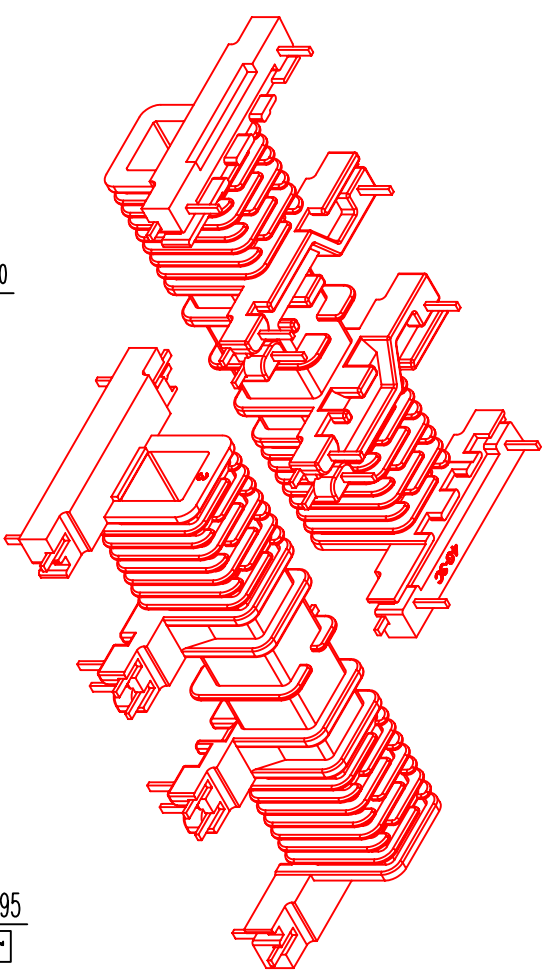
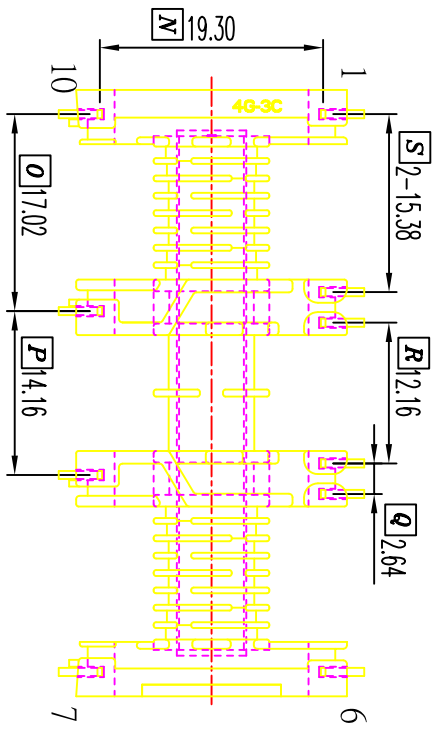
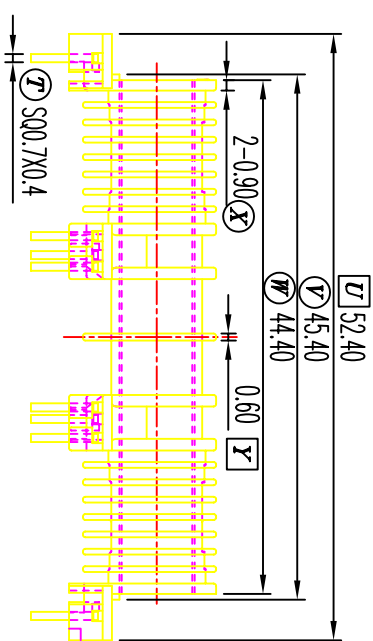
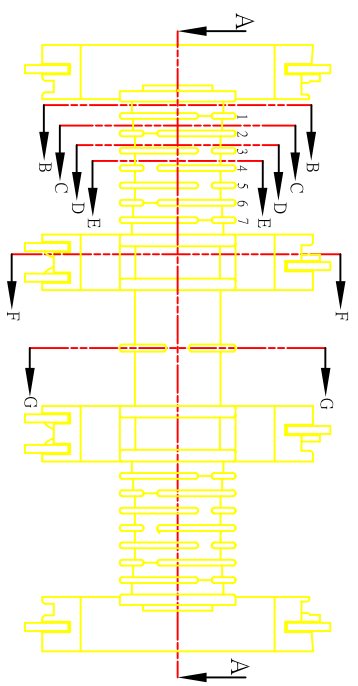

代表重要尺寸
代表次要尺寸

REV.	REVISION RECORD	DATE	REV.	REVISION RECORD	DATE
A			C		
B			D		

NAME	EEI-18-40-C BOBBIN	MATERIAL	PET FR330 (R3)	SCALE	1:5/1	ANGLE:	±1°
DRAWING NO.	HYS1804	PIN MATERIAL	CP WIRE	UNIT	m/m	REV.:	A
UL REC.:94V-0	PIN TENION LOAD: 2.0kg MIN						
TOLERANCES	0.13±0.08 3<K<10±0.1 10<K<18±0.12 18<K<50±0.15 50<K<80±0.2						
	PIN PITCH:±0.2 WALL THICKNESS:±0.15						

信詠塑膠工業股份有限公司
HSIN YUNG PLASTIC INDUSTRIAL CO.LTD
TEL:886-2-29953711 FAX:86-2-299910010
信詠塑膠電子廠
HSIN YUNG PLASTIC ELECTRONICS FACTORY
TEL:0709-86032011 FAX:0709-86035843

檢驗條件: